

Article number: 12307100060110
Description: KLEE-coil 307 100 060.110
M6 Hardened/zinc-plated Blue

Measures

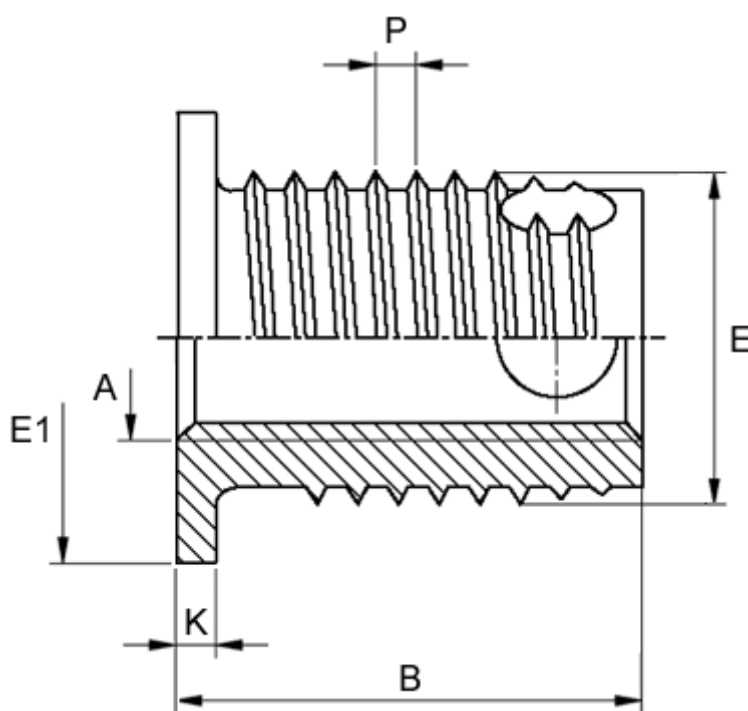

Female thread A	= M6
Flange diameter E1	= 13
Flange height	= 1.5
Length B	= 9.5
Male thread E	= 10
Min hole depth blind hole	= 10
Thread pitch P	= 1.25
Type	= 307 100 060 ...